

Highest quality for your skill



**DONATONI**  
HIGH INNOVATION STONE MACHINES

# ECHO 725 CNC

Centro di taglio a  
controllo numerico  
a 5 assi interpolati  
CNC cutting center with  
5 interpolated axes

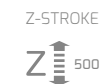

# ECHO 725 CNC



Ogni macchina Donatoni nasce con un cervello tecnologico all'avanguardia. Cambiano le funzioni, le dimensioni e le capacità, ma il punto fermo è un sistema intelligente di gestione del lavoro. Semplice da usare, eccezionale nei risultati.

Each Donatoni machine comes with cutting edge technology brain. Functions, dimensions, and performances can change, but the basic assumption is an intelligent system of work management. Simple to use, outstanding results.



  
**DONATONI**  
INNOVATION STONE M



## Tutto sotto controllo con la massima precisione Everything under control with the highest precision

ECHO 725 CNC è una fresa a ponte a controllo numerico a 5-6 assi interpolati con corsa asse Z di 500mm, testa porta disco rotante da  $-5^{\circ}$  a  $+365^{\circ}$  ed inclinabile da  $0^{\circ}$  a  $90^{\circ}$  per l'esecuzione di tagli ortogonali fino a 250mm, ideale per tagli obliqui, circolari, ellittici, inclinati, sagomature rettilinee, concave, convesse, ad arco, ellittiche, scavi di masselli a sezione bidimensionale e tridimensionale.

Nella versione "Tools" o "TOP", con elettromandrino controllato da inverter, può utilizzare utensili diamantati tipo: fresa a candela, mola da scavo, disco orizzontale. Disponibile inoltre nelle versioni due versioni: Echo-Belt e Echo-Twin.

ECHO 725 CNC is a 5-6 interpolated axes CNC bridge saw with Z axis stroke of 500mm, rotating blade head, swiveling from  $-5$  to  $+365$  degrees and tilting from 0 to 90 degrees, to perform orthogonal cuts until 250 mm thickness, ideal machine for performing oblique, circular, elliptical cuts, two-dimensional and three-dimensional digging and carving of blocks.

The "Tools" or "Top" versions can use diamond tools such as: milling wheels, drill cores and horizontal blade. Also available in the two versions: Echo-Belt and Echo-Twin.

# ECHO 725 CNC

## Particolari costruttivi / Structural details

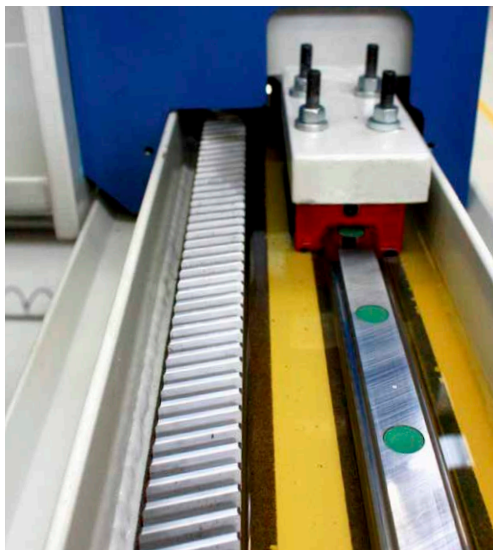

Scorrimento carrello porta disco (asse X e Y) su guide lineari a ricircolo di sfere in bagno d'olio.  
Blade carriage sliding (X and y axis) on recirculating ball linear guides in oil bath.



Movimentazione salita-discesa testa porta disco con vite a ricircolo di sfere, chiocciola e sistema di sicurezza ACS.

Head-carrying blade high-low drive with recirculating ball screw, lead nut and ACS safety system.

Scorrimento salita e discesa della testa (asse Z) su guide lineari a ricircolo di sfere.

Head up-down sliding (Z axis) on recirculating linear ball guides.



Per il movimento di tutti gli assi sono impiegati motori brushless e riduttori di alta precisione.  
Brushless motors and high precision gearboxes are used for all axes drive.



Rotazione testa (asse C) da -5° a 365°.

Inclinazione testa (asse A) da 0° a 90°.

Head rotation (C axis) from -5° to 365°.

Head inclination (A axis) from 0° to 90°.



## Accessori / Optional

### RIEPILOGATIVO OPTIONAL / SUMMARY OF OPTIONALS

Banco basculante piano legno o gomma	Tilting table with wood or rubber surface
Banco fisso piano legno o gomma	Fixed table with wood or rubber surface
Rilevatore spessore lastra	Slab thickness detector
Presetting disco, rileva diametro del disco	Blade presetting, it detects blade's diameter
Muri sostegno macchina in acciaio	Steel walls for machine support
Testa portadisco tools: motore con albero forato M48 per prolunga con filetto 1/2" gas	Tools blade-carrying head: hollow motor shaft, M48 for extension 1/2" gas thread
Testa portadisco top: elettromandrino ISO 40 con tirante	Top blade-carrying head: electrospindle ISO 40 with tie rod
Testa portadisco MTC: elettromandrino ISO 40 con sgancio pneumatico	MTC blade-carrying head: ISO 40 electrospindle with pneumatic release
Testa portadisco ATC: elettromandrino ISO 40 con cambio utensili automatico	ATC blade-carrying head: ISO 40 electrospindle with automatic tool changing
Magazzino cambio utensili automatico	Automatic tool changing magazine
Teleassistenza	Remote assistance
Echoframe, struttura monoblocco completa di banco ribaltabile piano legno	Echoframe, single monoblock structure with wooden-surface tilting or fix bench
Acquisizione fotolastra: photoslab	Photo slab capture: photoslab
Move system, ventose per spostamento pezzi	Move system, Multi section suction cups, for moving the pieces to be cut
Gruppo di taglio lower cut per taglio rinforzo o gocciolatoio	Lower cut unit for reinforcement cut or drip cut
Scan Cnc rilevatore di dime 2d	Scan CNC 2D templates detector
Software per la gestione di figure parametrizzate: PARAMETRIX	Software for the management of parametric figures: PARAMETRIX
DM_TL Programma di levigatura per piatto porta frankfurt o altri abrasivi	DM_TL program for polishing equipped with frankfurt-carrying plate

## Utensili / Tools

**ESEMPIO INGOMBRI CON PROLUNGA (CORSA ASSE Z 500MM)**  
 EXAMPLE OF EXTENSIONS DIMENSIONS (Z AXE STROKE 500MM)

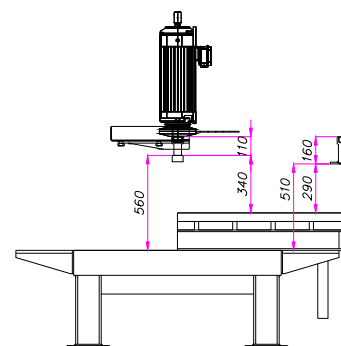

**RILEVATORE SPESSORE LASTRA (OPT.)**  
 SLAB THICKNESS DETECTOR (OPT.)

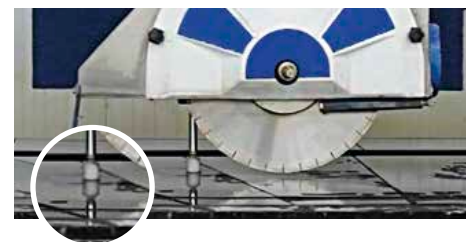

**PRESETTING DISCO (OPT.)**  
 BLADE PRESETTING (OPT.)

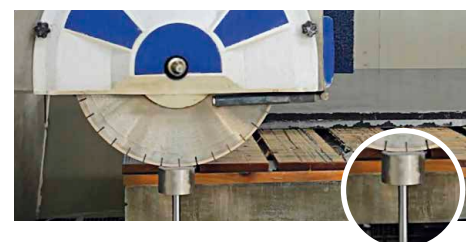

**UTENSILI DIAMANTATI UTILIZZABILI VERS. TOP ISO 40/TOOLS**  
 USABLE DIAMOND TOOLS VERS. TOP ISO 40/TOOLS



mole da scavo / milling wheels



mola ovale per rifinitura / milling wheel for sink



frese cilindriche / cylindrical milling cutters



disco orizzontale / horizontal blade



punta per bassorilievi / tip for bas-relief



punte per scrittura / tips for engraving



foretti / drill cores



disco verticale Ø max 725 mm, Ø minimo 400 mm  
 vertical blade max ø 725 mm, min. ø 400 mm

# ECHO 725 CNC

## Consolle comando macchina e software base / Machine control console and core operating system

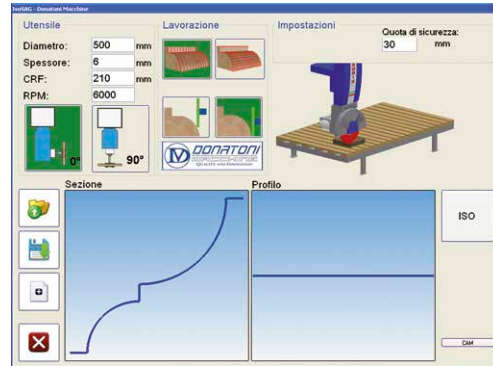

ISOSAG – MiniCAD software che permette di eseguire sagomature rettilinee o ad arco concavo e convesso, sia con disco in verticale che con disco orizzontale

ISOSAG – MiniCAD software to create shaping files to perform straight or concave and convex arc shapes with both vertical and horizontal blades

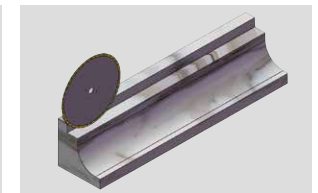
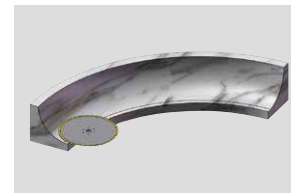

Interfaccia operatore con PC e video 15” touch-screen a colori  
Operator interface with PC and 15” color touch-screen monitor

Porta USB per trasferimento files  
USB port for file transfer

Comandi per la gestione manuale di tutti gli assi  
Controls for manual handling of all axes

**PROGRAMMI BASE  
INSTALLATI**  
BASIC PROGRAMS  
INSTALLED

FORATURA  
DRILLING



TAGLIO LASTRE COMBINATO  
COMBINED SLABS CUT



TAGLIO LASTRE COMBINATO OBLIQUO  
COMBINED OBLIQUE SLABS CUT



TAGLIO ELEMENTI CURVILINEI  
CURVILINEAR ELEMENTS CUT



TAGLIO INCLINATO  
INCLINED CUT

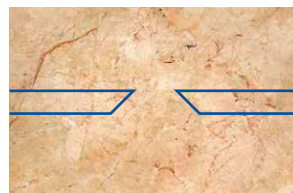

SCAVO SEMPLICE  
SIMPLE DIGGING



TAGLIO POLIGONI  
POLYGONAL CUT



TAGLIO CERCHIO ED ELLISSE  
CIRCULAR AND ELLIPTICAL CUT



TAGLIO PIANO CUCINA  
KITCHEN TOP CUT





## Software: EasyStone CAD/CAM

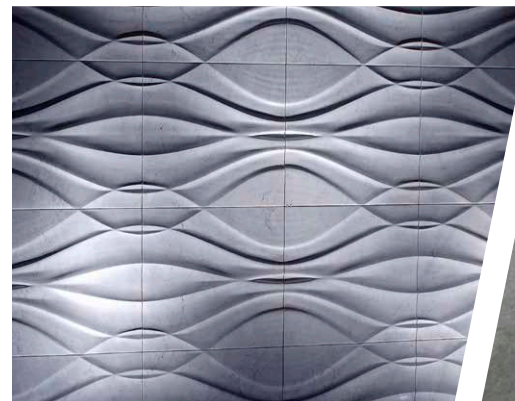
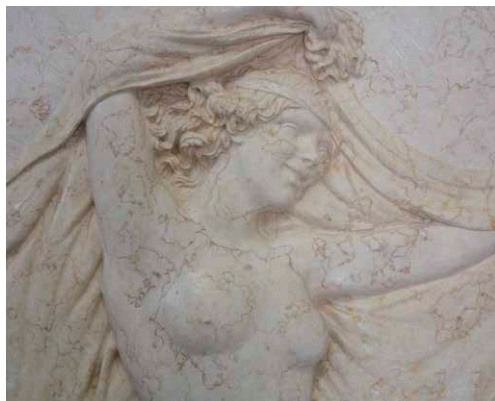

**Un software CAD/CAM potente, semplice ed intuitivo. Nella fase di progettazione permette di disegnare liberamente elementi geometrici e superfici: piani cucina, top bagno, colonne e sagome**

Il software consente di importare file 2D e 3D nei formati DXF, IGES, STL, PNT, STEP e RHINO e di definire superfici e sagome attraverso la scansione laser. Si possono impostare molteplici lavorazioni: sgrossature, forature, profilature, svuotamenti e lucidature, sono eseguite ottimizzando il processo di esecuzione.

La disposizione e la realizzazione dei pezzi è effettuata in automatico gestendo gli utensili ed il portautensili, con controllo delle interferenze delle lavorazioni.

EasyStone gestisce il tornio interpolato.

**A CAD / CAM powerful software, simple and intuitive. In the design phase it allows to draw freely geometric elements and surfaces: kitchen countertops, vanity tops, columns and silhouettes.**

The software allows import of 2D and 3D file formats DXF, IGES, STL, PNT, STEP and RHINO and to define shapes and surfaces by laser scanning. You can set multiple processes: roughing, drilling, profiling, emptying and polishing, are performed by optimizing the execution process.

The arrangement and production of pieces is automatically performed by managing tools and tool holders, with interference checking.

EasyStone manages the interpolated lathe.

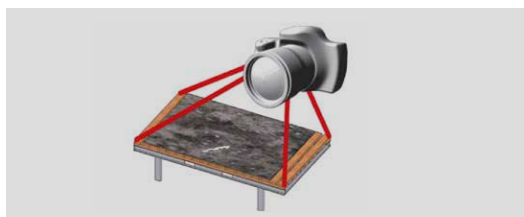
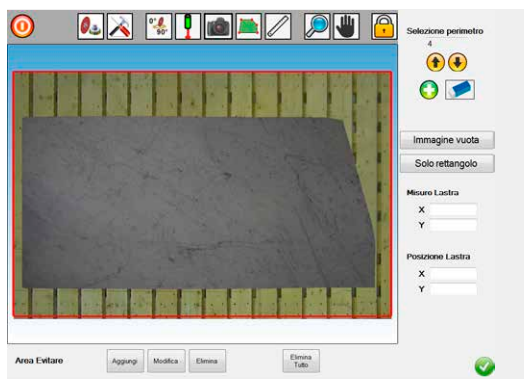

### FOTOCAMERA | CAMERA

Photoslab, per mezzo di una fotocamera, rileva automaticamente le misure della lastra da tagliare. Il sistema permette di velocizzare il posizionamento dei pezzi, evitando eventuali difetti oppure permettendo di eseguire tagli seguendo le venature del materiale.

Photoslab, by means of a camera, automatically detects the measurements of the slab to be cut. The system allows to speed up the positioning of the pieces, avoiding any defects or allowing to perform cuts along the veins of the material.

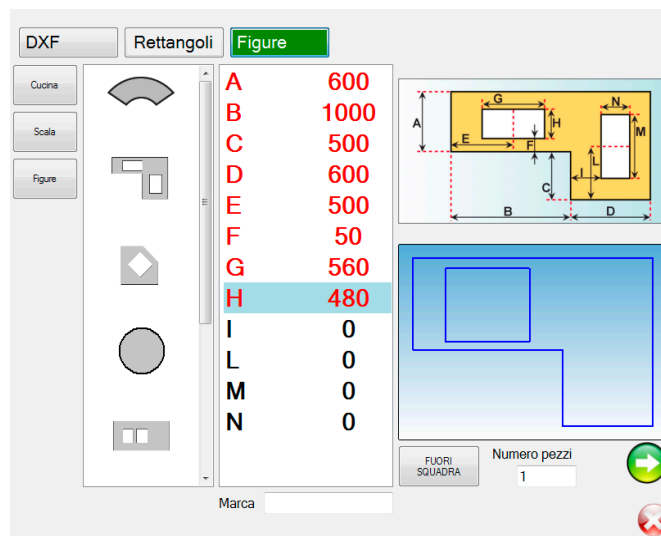

### Software per la gestione dei tagli: PARAMETRIX

Un software sviluppato dalla Donatoni Macchine pensato per ottimizzare la gestione dei tagli multipli su lastra. Parametrix, in base alla superficie disponibile, consente di impostare in automatico la disposizione dei pezzi e la sequenza dei tagli, ottimizzando i tempi e riducendo gli scarti di materiale.

Parametrix dà il meglio di sé quando è abbinato ai sistemi Photoslab e MoveSystem, che permettono il rilevamento automatico delle misure lastra e la movimentazione, attraverso un sistema di ventose, dei pezzi tagliati, riducendo al minimo l'intervento dell'operatore.

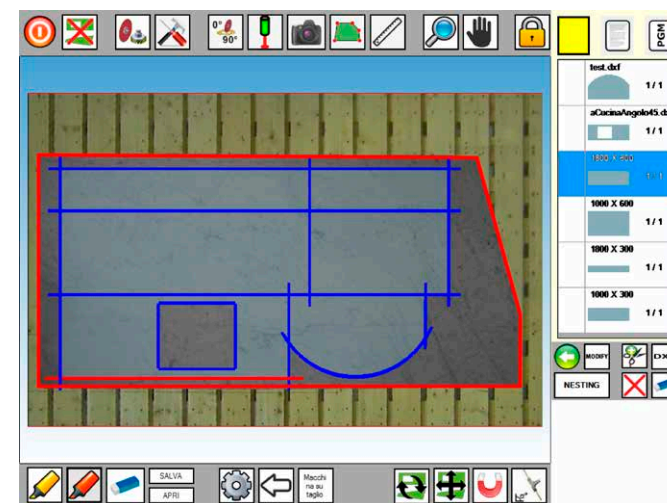

### Software for the management of cuts: PARAMETRIX

A software developed by Donatoni Macchine; designed to optimize the management of multiple cuts on the slab. Parametrix, according to the area available, allows you to automatically set the pieces position and the sequence of cuts, optimizing time and reducing material waste.

Parametrix gives its best when it is combined with the Photoslab and Move System, which allow the automatic detection of slab measurements and handling, through a system of suction cups, minimizing operator intervention.





## Move System (patent pending)

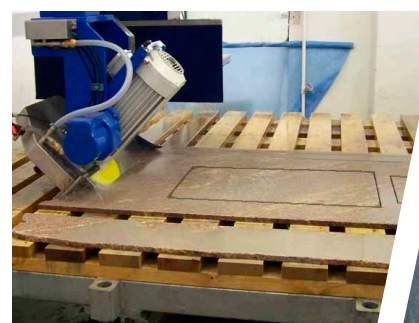
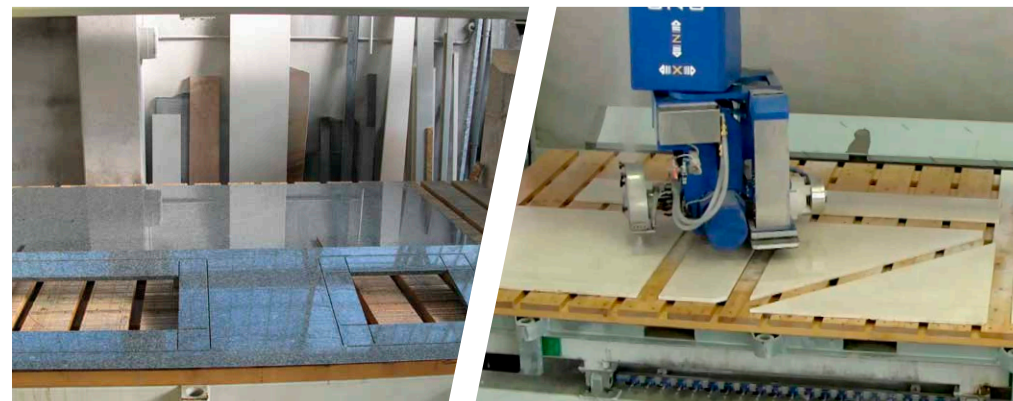
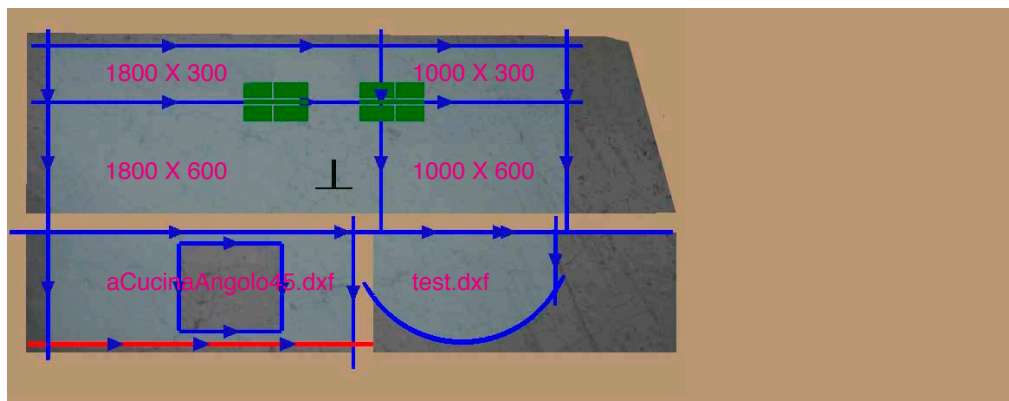

## SISTEMA VENTOSE

Move System è un innovativo sistema di ventose per la movimentazione dei pezzi tagliati. Il suo utilizzo riduce i tempi morti, aumenta la produttività limitando al minimo il materiale di scarto.

## MOVE SYSTEM

Move System is an innovative system of vacuum cups for handling cut to sizes pieces. Its use reduces downtime and increases productivity while minimizing material waste.

# ECHO 725 CNC

Sistemi per grandi produzioni / Large-scale systems

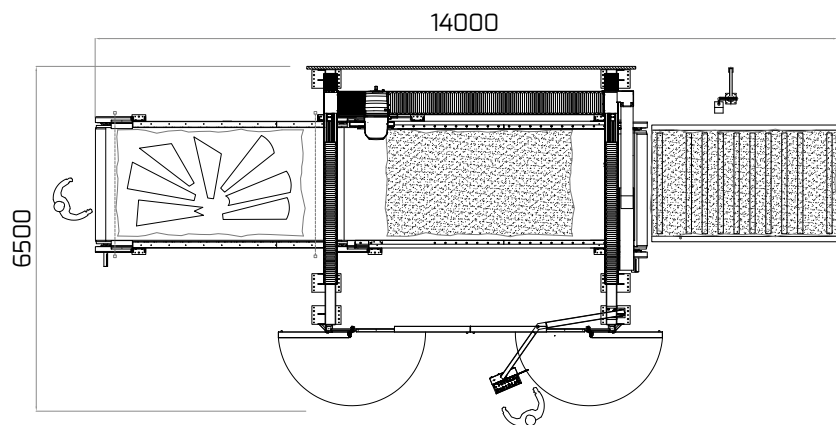

## Echo Belt

Sistema di movimentazione lastre tramite trasportatore in gomma: consente la riduzione dei tempi morti derivanti da carico, scarico e programmazione  
Slab handling system through rubber conveyor belts: it reduces the machine's downtime resulting from loading, unloading and programming operations

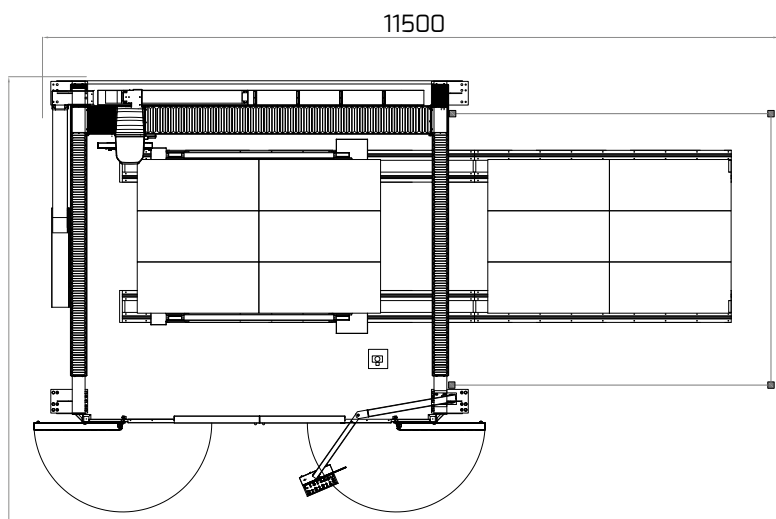

## Echo Twin

Sistema di scambio banchi automatico: consente la riduzione dei tempi morti derivanti da carico, scarico e programmazione  
Echo Twin Automatic working tables' interchanging system: it reduces the machine's downtime resulting from loading, unloading and programming operations



## Dimensione / Dimensions

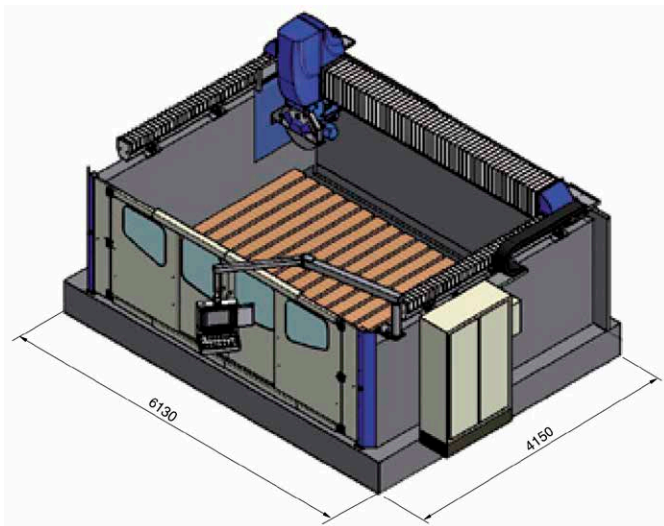
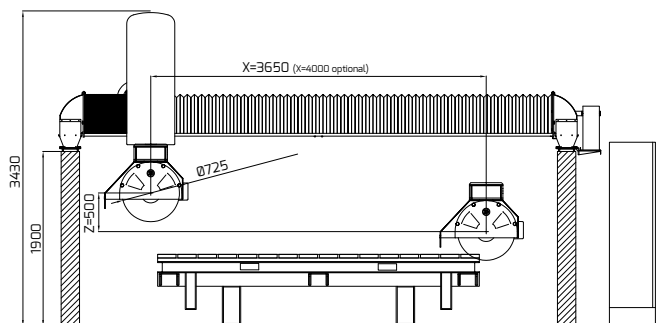

## Caratteristiche Tecniche / Technical Features

Numero massimo assi interpolati Max number of interpolated axes	N°	5	Potenza motore disco Blade motor power	kW Hp	17 / 56 23 / 56
Corsa carrello asse X * Carriage stroke axis X *	mm in	3650 / 4000 (opt.) 143/158	Rotazione disco con inverter (STANDARD) Blade rotation with inverter (STANDARD)	giri/min Rpm	0 / 2400
Corsa ponte asse Y * Bridge stroke axis Y *	mm in	2450 / 2950 96/116	Rotazione utensile con optional TOOLS/ TOP ISO 40 Tool rotation with optional TOOLS / TOP ISO 40	giri/min Rpm	0 / 5000 TOOLS 0 / 6000 TOP
Corsa salita / discesa asse Z Vertical stroke axis Z	mm in	500 20	Diametro albero mandrino Spindle shaft diameter	mm in	50 / 65 2 / 2.5
Rotazione testa porta disco asse C Blade-carrying head rotation (axis C)	gradi degrees	-5° / 365°	Velocità massima assi X-Y Max speed X-Y axes	m/min ft/min	45 148
Inclinazione testa porta disco asse A Blade-carrying head tilting (axis A)	gradi degrees	0 / 90	Velocità massima testa asse Z Head max speed Z axis	m/min ft/min	6 20
Dimensioni del banco * Working table dimensions *	mm in	2000x3500 79x138	Consumo acqua Water consumption	l/min gal/min	50 13
Diametro minimo del disco Minimum blade diameter	mm in	400 16	Consumo aria Air consumption	l/min gal/min	10 3
Diametro massimo del disco Maximum disc diameter	mm in	725 29	Tensione standard Standard voltage	Volt/Hz	400 / 50
Profondità massima di taglio con disco 725 mm Maximum cutting depth with blade 725 mm	mm in	250 10	Peso complessivo della macchina Approx. total weight of the machine	kg	4250

\* Altre misure su richiesta  
\* different dimensions under request

I dati non sono impegnativi e la ditta costruttrice si riserva la facoltà di modificarli senza preavviso per migliorare le prestazioni del prodotto  
Technical data are not binding and the firm has the right to modify them without notice due continuous improvement of the product

### ECHOFRAME

Versione macchina monoblocco, disponibile con banco fisso o ribaltabile  
Monobloc version, available with fixed or tilting bench

### Donatoni Macchine Srl

Via Napoleone 14, 37015 Domegliara / Verona / Italy  
Tel. +39 045 6862548  
Fax +39 045 688 43 47  
info@donatonimacchine.eu  
www.donatonimacchine.eu



## Un'azienda al servizio del cliente! / Customer service is our business **Una storia di successo / A success story**

L'impegno verso i nostri clienti non si esaurisce con la consegna della macchina, ma continua, offrendo un supporto ed una assistenza postvendita di qualità assoluta. La possibilità di implementare su tutte le nostre macchine il servizio di 'Tele Assistenza', permette al nostro staff tecnico di poter accedere virtualmente sulla macchina del cliente ed eseguire controlli, verifiche ed aggiornamenti, come se si trovasse lì di persona. Il nostro personale, altamente qualificato ed appositamente formato sul concetto di Customer Oriented, è sempre a disposizione del cliente.

OUR commitment to our customers does not end with the delivery of the machine. Our commitment continues by offering support and the highest level of after-sales service. Through our "Remote Assistance" module, our technical staff has the ability to have virtual access on the customer's machine to perform checks, verifications, and updates as if they are there in person. Our staff, highly qualified and trained on the concept of Customer Service, is always available at the customer's disposal.

Donatoni Macchine, fondata da Donatoni Vittorio nel 1959, da oltre 50 anni ha la propria sede a Domegliara in provincia di Verona, una tra le principali zone di trasformazione e lavorazione del marmo e del granito. La lunga esperienza maturata negli anni in varie attività del settore lapideo rappresenta una garanzia di serietà e competenza indispensabili per proporre idee e soluzioni innovative e concrete nella realizzazione delle macchine per la lavorazione del marmo e del granito. L'organizzazione aziendale composta da personale tecnico e commerciale altamente qualificato completano il profilo di una realtà volta a soddisfare il cliente in ogni dettaglio.

Donatoni Macchine, founded by Vittorio Donatoni in 1959, for over 50 years has been headquartered in Domegliara, in the province of Verona, one of the main marble and granite processing areas. Years of experience gained in the stones business are behind the reputation and the expertise that permit Donatoni Macchine to offer innovative and practical ideas and solutions in design of marble and granite processing machines. Company organization, consisting of highly qualified technical and sales staff, completes the picture of a company that aims at fulfilling all customer's requirements.